

DATA: / /

● CONTE E ESCREVA, NOS QUADRINHOS, QUANTAS VEZES A LETRA A APARECE EM CADA UMA DAS PALAVRAS.

ABACAXI

COLA

AVIÃO

BÚFALO

ANEL

PANELA

● ESCREVA A VOGAL A NO FINAL DAS PALAVRAS:

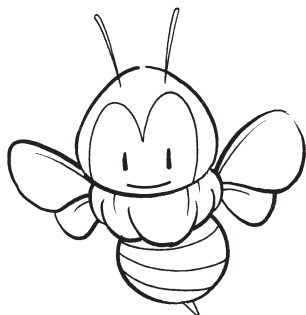

ABELH_____

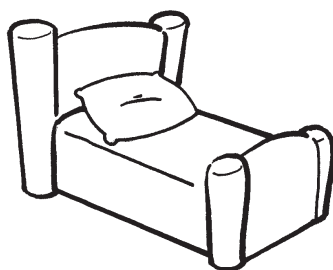

CAM_____

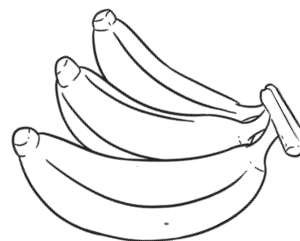

BANAN_____

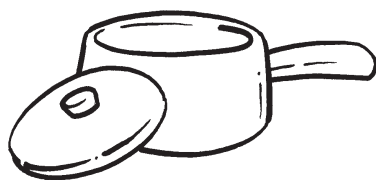

PANEL_____

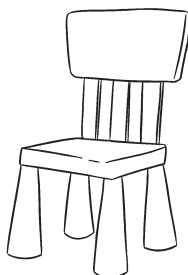

CADEIR_____



CAS_____

DATA:

● **PINTE APENAS A PALAVRA QUE SE RELACIONA COM A FIGURA.**

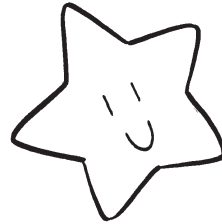
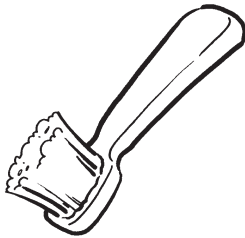

ESPADA

EMA

ESTRADA

ELEFANTE

ESCOVA

ESTRELA

ESCOLA

ELEVADOR

● **CIRCULE, NO TEXTO, AS PALAVRAS EM QUE APARECE A LETRA E.**



VAMOS OUVIR!

**BATATINHA QUANDO NASCE
SE ESPARRAMA PELO CHÃO.
MENININHA QUANDO DORME
PÕE A MÃO NO CORAÇÃO.**



DOMÍNIO PÚBLICO

DATA:

🌀 **OBSERVE A PALAVRA ABAIXO:**

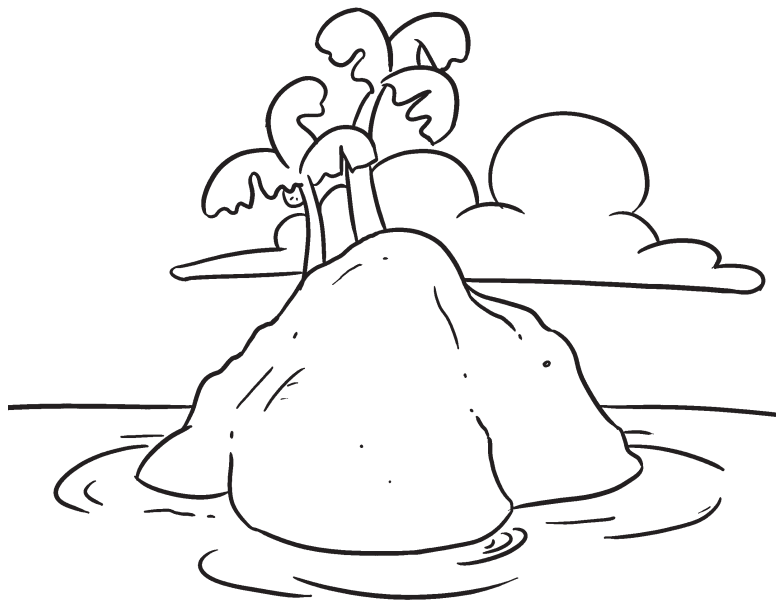

ILHA

QUANTAS LETRAS TÊM A PALAVRA ILHA?

QUANTAS VOGAIS?

QUAIS SÃO ELAS?

QUANTAS CONSOANTES?

QUAIS SÃO ELAS?

DATA: / /

● CIRCULE, NO TEXTO ABAIXO, AS PALAVRAS EM QUE APARECE A LETRA O.



VAMOS OUVIR!

A CASINHA DA VOVÓ
É COBERTA DE CIPÓ:
O CAFÉ TÁ
DEMORANDO, COM
CERTeza NÃO TEM PÓ.

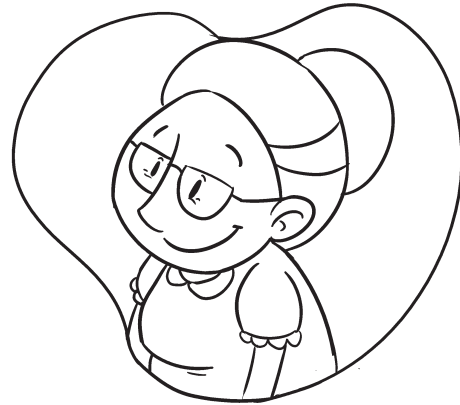

DOMÍNIO PÚBLICO

● PINTE AS FIGURAS CUJO NOME TEM A LETRA O.

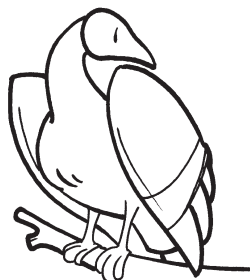

URUBU



AVIÃO



ONDA

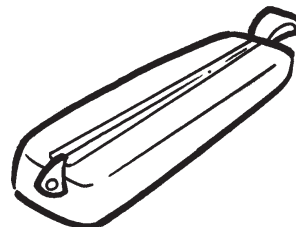

ESTOJO

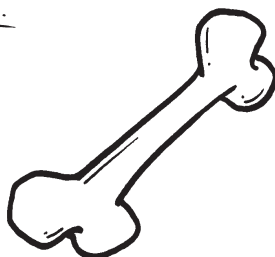

OSSO

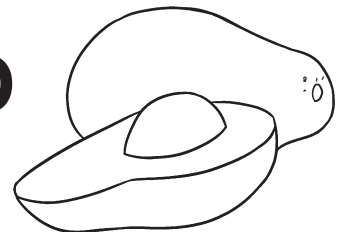

ABACATE

DATA:

● COMPLETE AS PALAVRAS USANDO A LETRA U.

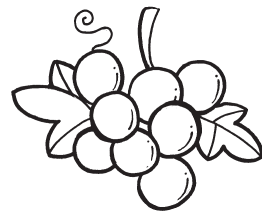
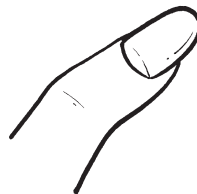
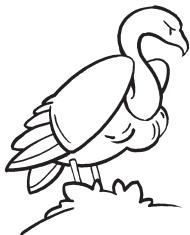

__RUBU __RSO __NHA __VA

● CIRCULE AS LETRAS QUE FORMAM AS PALAVRAS ABAIXO:

UMBU

D S U B S U V M

UMBIGO

U M I Q L B G O P

UIVAR

U I A T S X V R

UNIDADE

D N B I A S F Q U E D

DATA: / /

● PREENCHA AS PALAVRAS COM VOGAIS QUE ESTÃO FALTANDO.



B ___ **C** ___



L ___ **V** ___



P ___ **R** ___ **L** ___ **T** ___



C ___ **S** ___



G ___ **T** ___

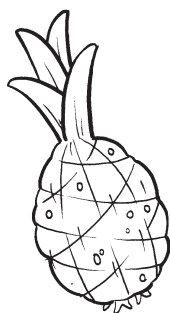

___ **B** ___ **C** ___ **X** ___



V ___ **L** ___

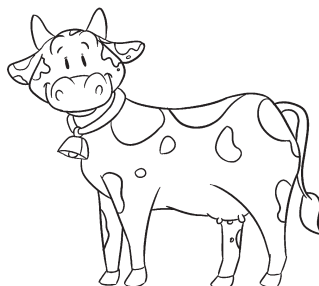

V ___ **C** ___



B ___ **L** ___

DATA: / /

● COMPLETE O FINAL DE CADA PALAVRA COM ã
OU ão.

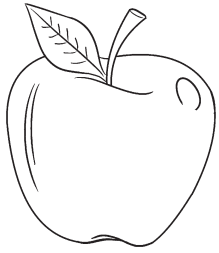

MAÇ _____

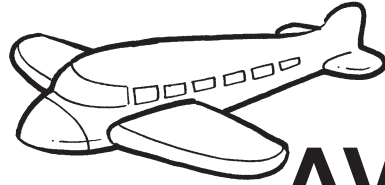

AVI _____

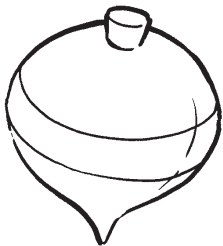

PI _____

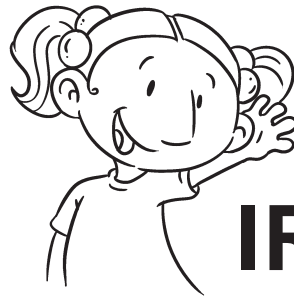

IRM _____



BOT _____

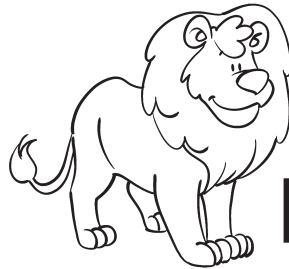

LE _____

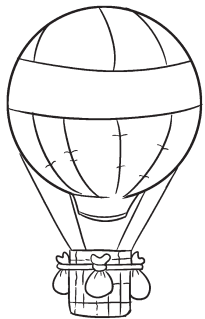

BAL _____



R _____

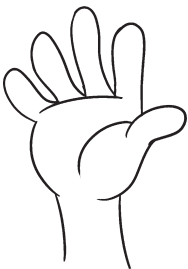

M _____

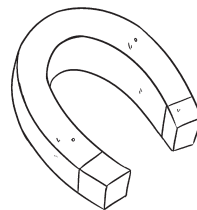

ÍM _____

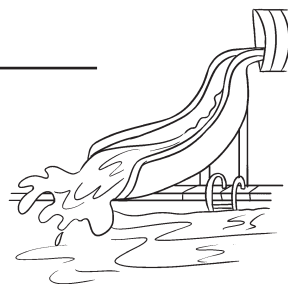

TOBOG _____

DATA:

● COMPLETE AS PALAVRAS USANDO A LETRA A.



MENIN_____

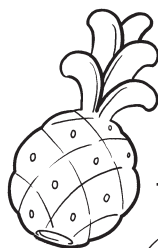

_____B_____C_____XI

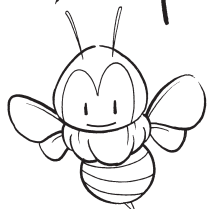

_____BELH_____



LU_____

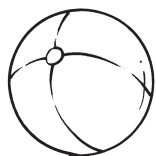

BOL _____



L_____T_____

● PINTE A PALAVRA EM QUE A VOGAL A APARECE TRÊS VEZES.

PANELA

ARARA

BONECA

DATA: / /

● LEIA AS PALAVRAS.

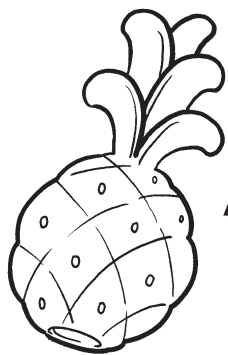

ABACAXI

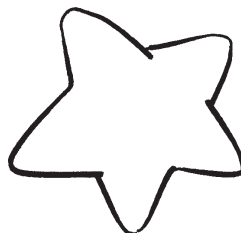

ESTRELA



ILHA



UVA



ESCOVA



ANEL

● DE ACORDO COM AS PALAVRAS ACIMA, ESCREVA NOS QUADROS ABAIXO.

A PALAVRA COM 3 LETRAS

A PALAVRA COM 6 LETRAS

AS PALAVRAS COM 7 LETRAS

DATA:

● PINTE, NAS PALAVRAS, AS VOGAIS.



PETECA

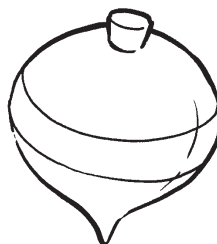

PIÃO

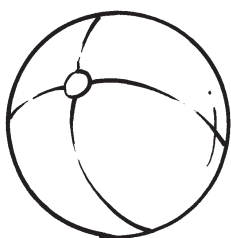

BOLA

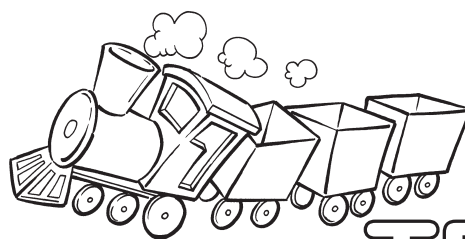

TREM

● PINTE, NAS PALAVRAS, AS CONSOANTES.

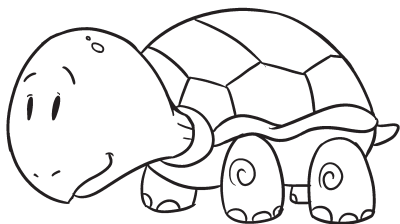

TARTARUGA

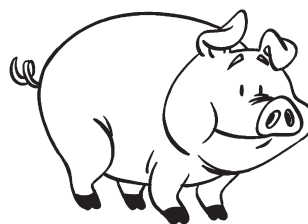

PORCO

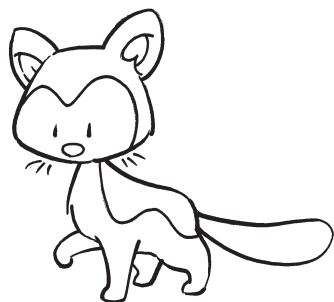

GATO

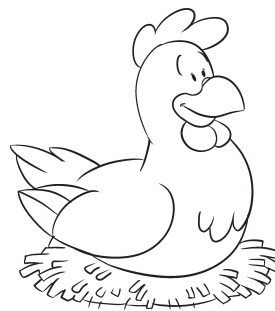

GALINHA

DATA:

● **ESCREVA NO CADERNINHO LETRAS QUE VOCÊ JÁ CONHECE.**

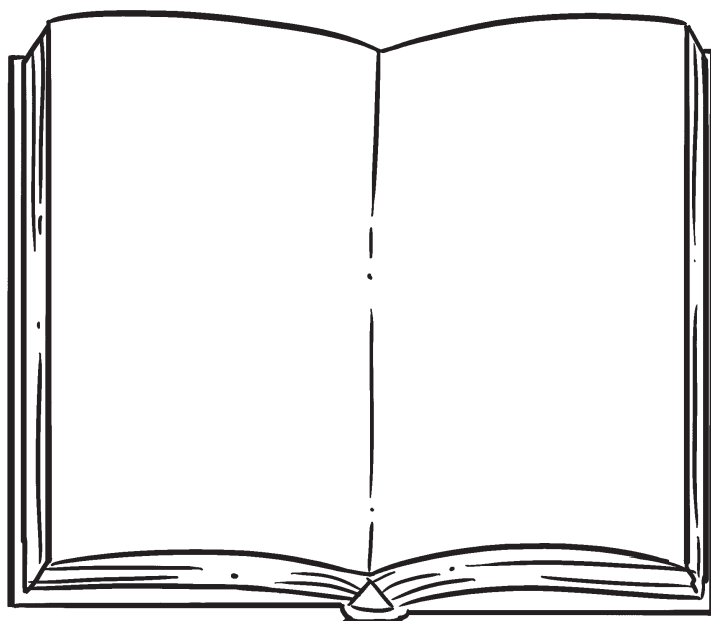

AGORA, PESQUISE, EM JORNAIS E REVISTAS, VÁRIAS LETRAS QUE VOCÊ ENCONTRAR.

DATA:

🔍 PESQUISE, EM JORNAIS E REVISTAS, PALAVRAS QUE COMEÇAM E TERMINAM COM:

COMEÇA

TERMINA

Aa

Ee

li

Oo

Uu

DATA:

● OBSERVE O SEU NOME NO CADERNO E PINTE AS LETRAS QUE O FORMA.

A B C D E F G H I J
K L M N O P Q R S T
U V W X Y Z

DEPOIS, ESCREVA SEU NOME NO QUADRO ABAIXO.

● PESQUISE, EM REVISTAS OU JORNAIS, AS LETRAS DO SEU NOME E COLE-AS, NA ORDEM CERTA, ESCREVENDO-O.

DATA:

🕒 PESQUISE, RECORTE E COLE AS LETRAS QUE FORMAM O NOME DAS PESSOAS DA SUA FAMÍLIA.

ESTE É MEU PAI. SEU NOME É:

ESTA É MINHA MÃE. SEU NOME É:

VOCÊ TEM IRMÃOS? SIM NÃO

QUANTOS?

🕒 PESQUISE AS LETRAS DO NOME DA PROFESSORA E COLE-AS AQUI NA ORDEM EM QUE APARECEM.

QUANTAS LETRAS TEM O NOME DA PROFESSORA?

DATA:

 **DESENHE SUA FAMÍLIA AQUI.**

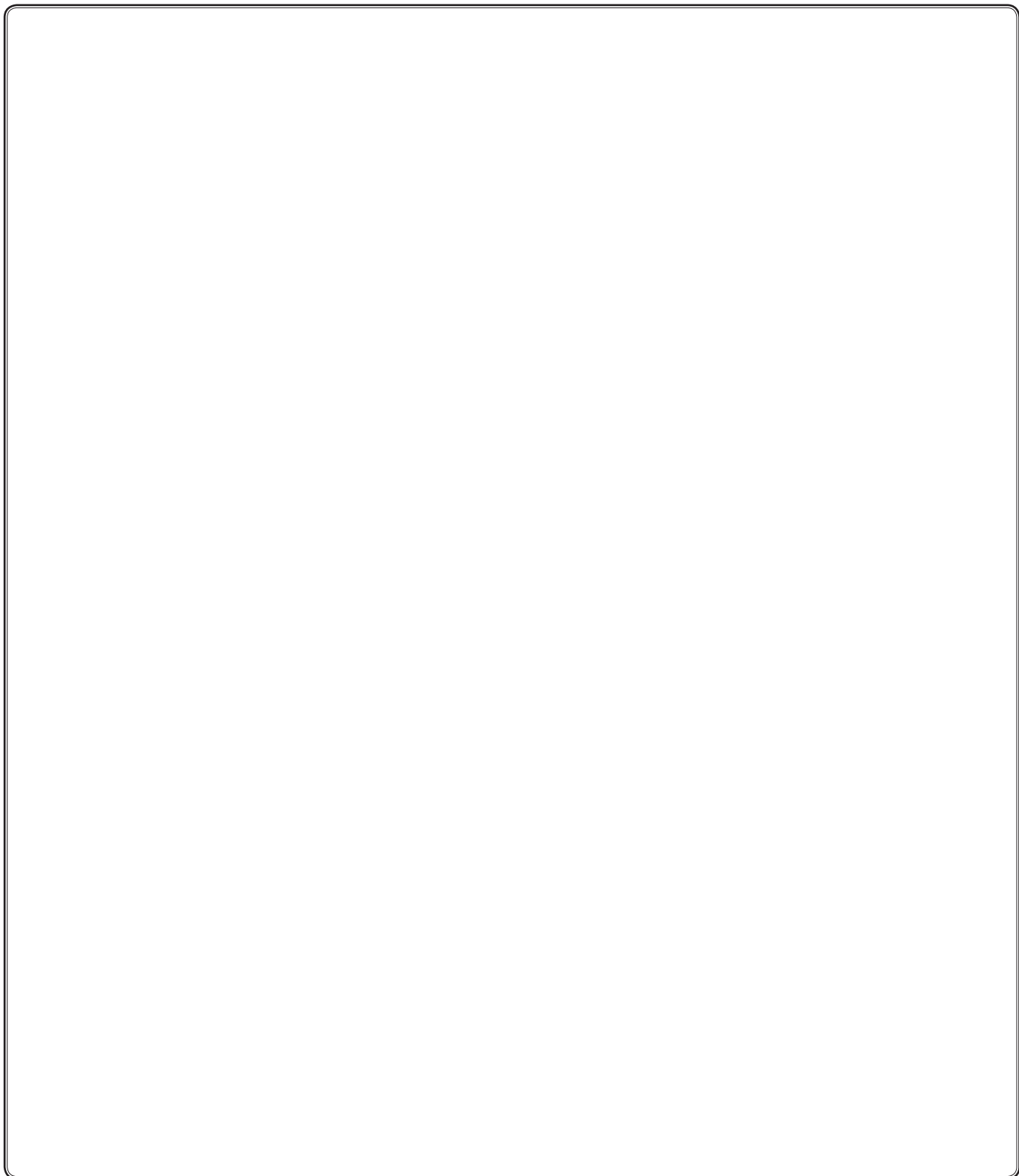

DATA:

● AS LETRAS DO ALFABETO ESTÃO TODAS BAGUNÇADAS. COLOQUE-AS EM ORDEM, SEGUINDO O QUADRO ABAIXO.

V I X Q B E D L T R A W P
C O F U S H J G Z M N K Y

● ESCREVA PALAVRAS QUE TENHAM AS LETRAS A SEGUIR.

P

A

M

G

DATA: / /

VAMOS CANTAR!

A CANOA VIROU

A CANOA VIROU,
POIS DEIXARAM ELA VIRAR.
FOI POR CAUSA DE VERINHA,
QUE NÃO SOUBE REMAR.
SE EU FOSSE UM PEIXINHO
E SOUBESSE NADAR,
EU TIRAVA VERINHA
LÁ DO FUNDO DO MAR.

DOMÍNIO PÚBLICO

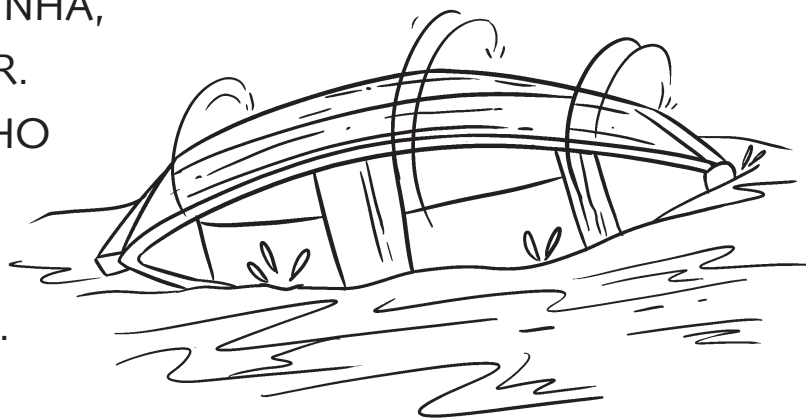

🕒 CIRCULE, NO TEXTO, COM A AJUDA DA PROFESSORA, AS RESPOSTAS ÀS PERGUNTAS ABAIXO DE ACORDO COM A LEGENDA.

QUAL É O NOME DA CANTIGA?

O QUE ACONTECEU COM A CANOA?

FOI POR CAUSA DE QUEM QUE A CANOA VIROU?

DE ONDE EU TIRARIA VERINHA?

DATA: / /

● PESQUISE, EM JORNAIS E REVISTAS, PALAVRAS QUE COMECEM COM:



BOLA

B



CASA

C

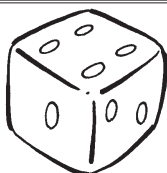

DADO

D

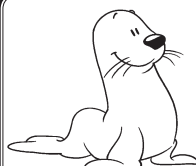

FOCA

F



GATO

G

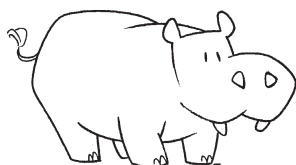

HIPOPOTAMO

H

DATA: / /

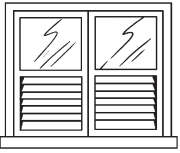

JANELA



KIWI



LATA

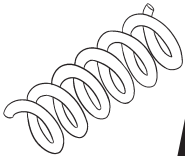

MOLA



NAVIO



PATO

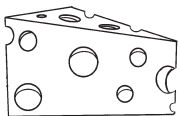

QUEIJO



DATA: / /



RATO

R



SAPATO

S

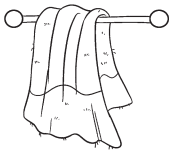

TOALHA

T



VELA

V



WALTER

W



XÍCARA

X



ZEBRA

Z

DATA: / /

● PINTE AS PALAVRAS QUE COMEÇAM COM A MESMA LETRA.



CENOURA

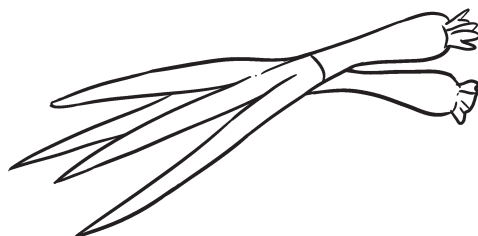

CEBOLINHA

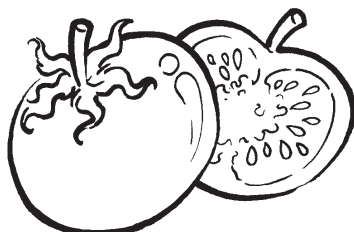

TOMATE

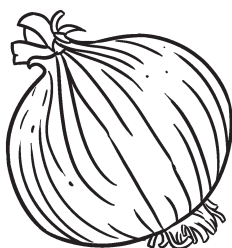

CEBOLA

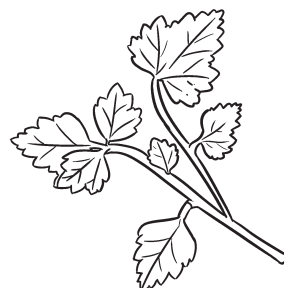

COENTRO

● RECORTE, DE JORNAIS OU REVISTAS, FRUTAS QUE COMEÇAM COM:

M

A

B

DATA: / /

● PROCURE ESTES NOMES NO DIAGRAMA E PINTE-OS BEM CAPRICHADO.

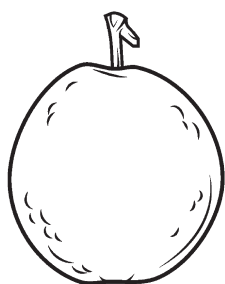

GOIABA

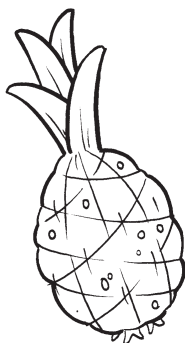

ABACAXI



UVA

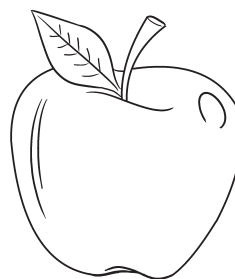

MAÇÃ

R	M	Q	M	A	Ç	Ã
G	O	I	A	B	A	P
N	S	U	V	A	T	O
A	B	A	C	A	X	I

DATA: / /

🎯 JUNTE AS SÍLABAS DA MESMA COR E ESCREVA, NO ESPAÇO ABAIXO, AS PALAVRAS FORMADAS.

BU **LO** **BO** **BO** **DE** **LE** **BI** **LA** **GO**

🎯 CANTE COM SUA PROFESSORA.



VAMOS CANTAR!

REBOLA, BOLA,
VOCÊ DIZ QUE DÁ NA BOLA,
NA BOLA VOCÊ NÃO DÁ.

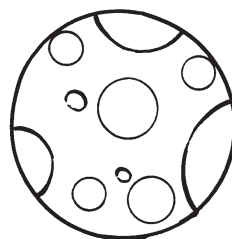

🎯 CIRCULE NO TEXTO, A PALAVRA **BOLA**, TODA VEZ QUE VOCÊ A ENCONTRAR.

🎯 QUANTAS LETRAS TEM A PALAVRA **BOLA**?

DATA: / /

● **ESCREVA AS SÍLABAS QUE FALTAM E FORME PALAVRAS, COM A AJUDA DE SUA PROFESSORA.**



____PO



BONE____

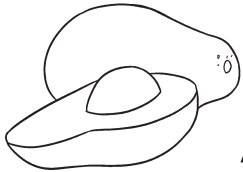

ABA____TE

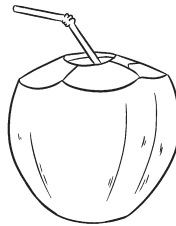

____CO



____VALO

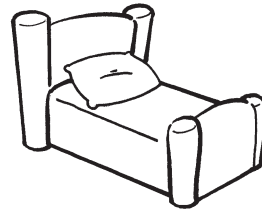

____MA



____DEADO



BO____

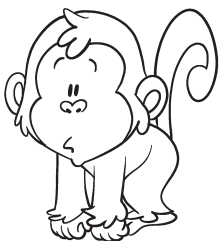

MA____CO

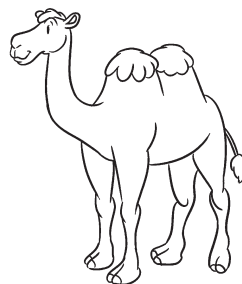

____MELO



____LA

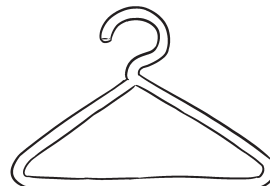

____BIDE

DATA:

🌀 TROCANDO O **B** DE “BOLA”, VOCÊ IRÁ FORMAR OUTRAS PALAVRAS.

TENTE E DESCUBRA.

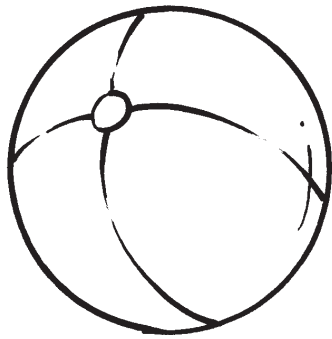

BOLA

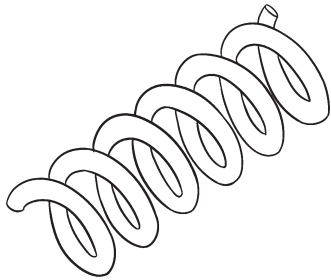

___OLA

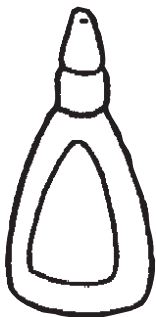

___OLA

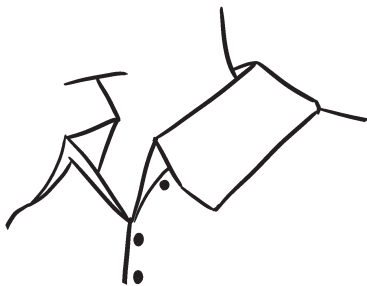

___OLA

DATA: / /

🌀 JUNTE AS SÍLABAS E ESCREVA AS PALAVRAS.

BO

DE

DA

DO

DE

DO

CA

BI

DE

🌀 DESENHE UMA FIGURA PARA CADA PALAVRA QUE VOCÊ DEBSCOBRIU.

DATA: / /

🌀 **COPIE O TRAVA-LÍNGUA ABAIXO, SEPARANDO AS PALAVRAS NOS QUADRINHOS.**



TRAVA-LÍNGUA!

FAROFAFEITACOM
FARINHAFOFAFAZ
FOFOCAFEIA.

DOMÍNIO PÚBLICO



DATA:

🎧 LEIA A PALAVRA ABAIXO:

GELADEIRA

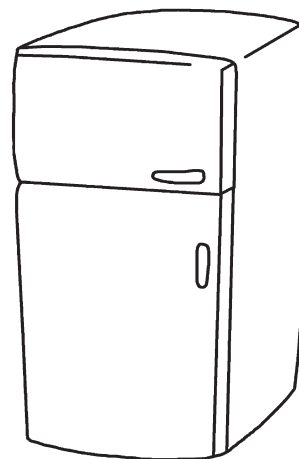

CIRCULE TODAS AS VOGAIS E MARQUE TODAS AS CONSOANTES.

QUANTAS VOGAIS VOCÊ CIRCULOU?

QUAIS FORAM ELAS?

QUANTAS CONSOANTES VOCÊ MARCOU?

QUAIS FORAM ELAS?

🎧 **PESQUISE OUTRAS PALAVRAS QUE COMEÇEM COM A LETRA G E COPIE-AS NO ESPAÇO ABAIXO:**

DATA: / /

🌀 **FORME PALAVRAS COM AS SÍLABAS ABAIXO DE ACORDO COM A NUMERAÇÃO.**

HO **HI** **CE** **MO** **E** **HOR** **PO**
1 2 3 4 5 6 7

HÉ **NA** **TA** **RA** **LI** **PÓ**
8 9 10 11 12 13

1,11

8,12,3

6,10

2,5,9

2,7,13,10,4



DATA: / /

● COPIE NO QUADRO APENAS AS PALAVRAS QUE TÊM A LETRA J.

JANETE

JANELA

SORVETE

JAULA

CARRO

MELANCIA

JOÃO

JOSÉ

PIRULITO

JACA

JÚLIA

JABUTI



DATA:

FORME PALAVRAS, JUNTANDO AS SÍLABAS ABAIXO:

LE BA TA LU MO A LI LO

1 2 3 4 5 6 7 8

LA MÃO BO LÃO LU VA ãO MA

9 10 11 12 13 14 15 16

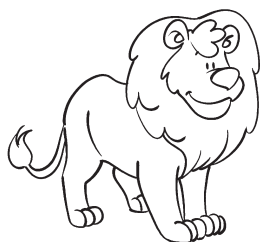

1,15



13,6

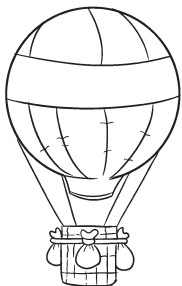

2,12



16,9



8,11

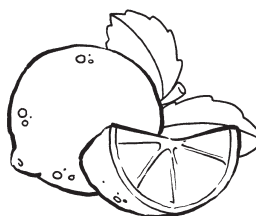

7,10

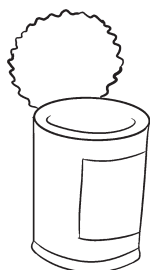

9,3

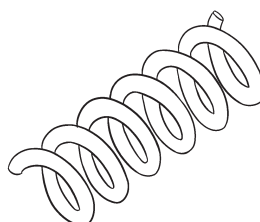

5,9

DATA: / /

● FAÇA A CRUZADINHA ESCREVENDO OS NOMES DOS DESENHOS DE ACORDO COM A NUMERAÇÃO.

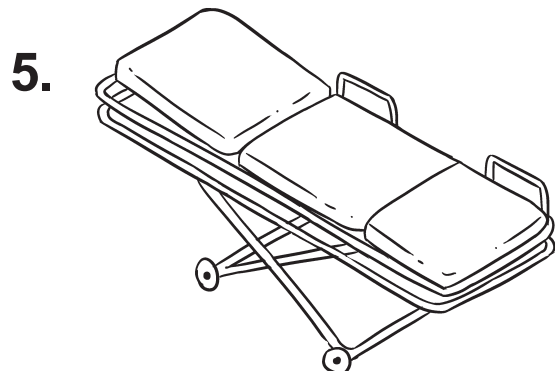
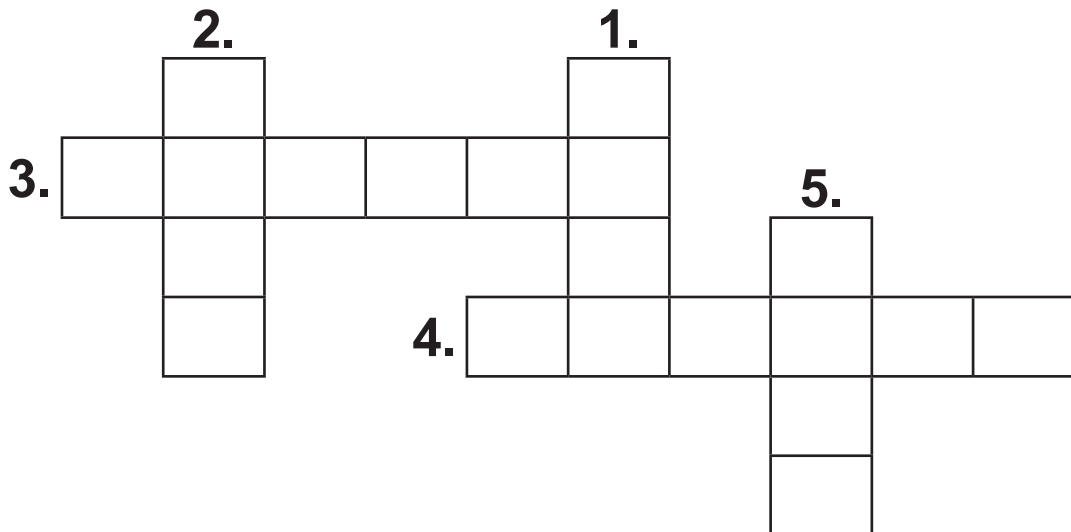
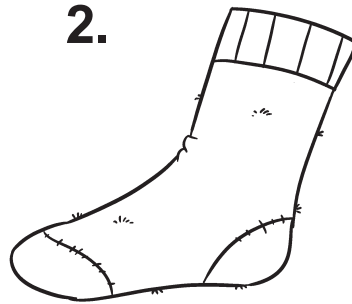
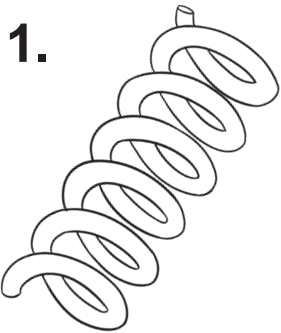

DATA: / /

🌀 TROQUE OS NÚMEROS POR SÍLABAS.

CA	NE	VO	BO	NA	NO	TI	LA	VE	NU
1	2	3	4	5	6	7	8	9	10

2+9

6+9

5+4

6+9+8

🌀 EXCLUA AS LETRAS QUE ESTÃO NA COR CINZA E FORME PALAVRAS COM AS RESTANTES.

N L O V L A E T L S A

L I C E A T N O V R A

N S T U V O M E R M

N T O M S V I U S O

DATA:

🌀 **FORME PALAVRAS:**

PA { **PAGAIO** —
NELA —

PE { **LADO** —
NA —

PI { **ÃO** —
POCA —

PO { **MADA** —
TE —

PU { **LO** —
PILA —

DATA: / /

🎯 LEIA E CIRCULE A PALAVRA QUE CORRESPONDE A CADA DESENHO.

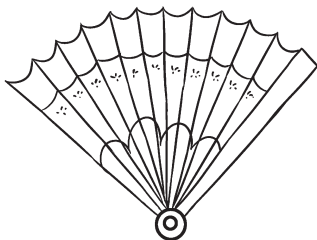

MOLEQUE
LEQUE
PEQUENO

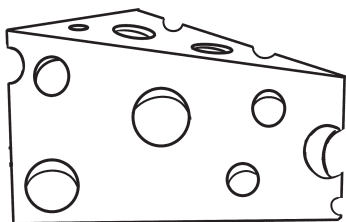

QUIABO
CAQUI
QUEIJO

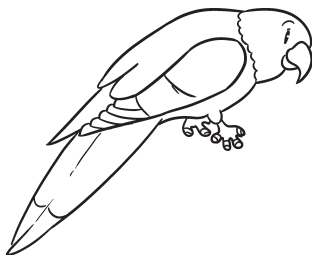

MÁQUINA
PERIQUITO
TANQUE

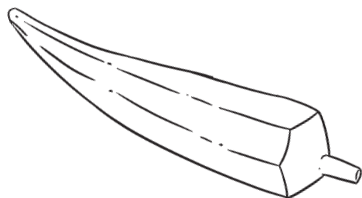

AQUI
QUEDA
QUIABO

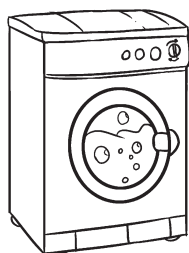

MÁQUINA
AQUILO
QUIETO

DATA: / /

● **ESCREVA O NOME DAS FIGURAS DE ACORDO COM AS PALAVRAS DO QUADRO.**

RODA RODO RIO
RÁDIO ROUPA REI
REDE RELÓGIO RATO

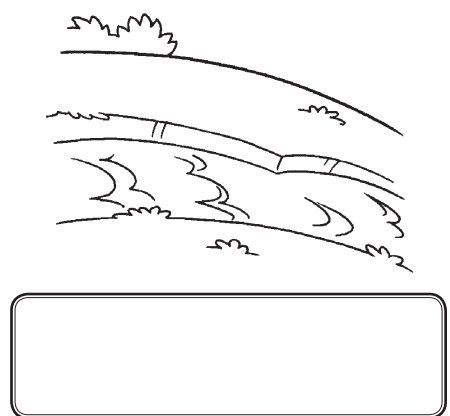
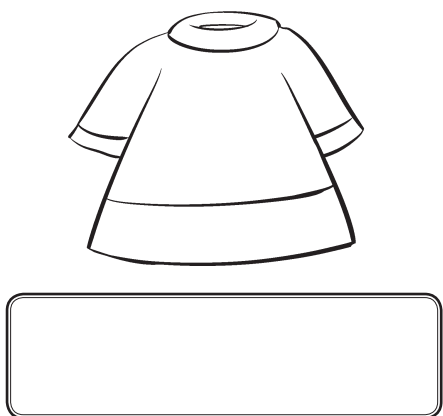
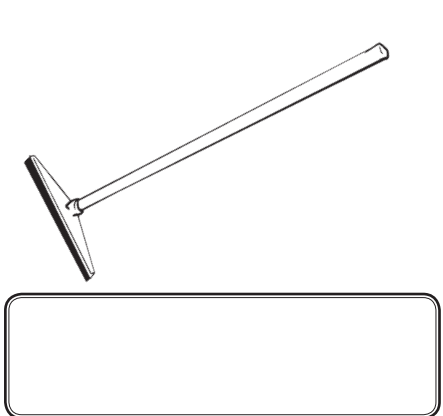
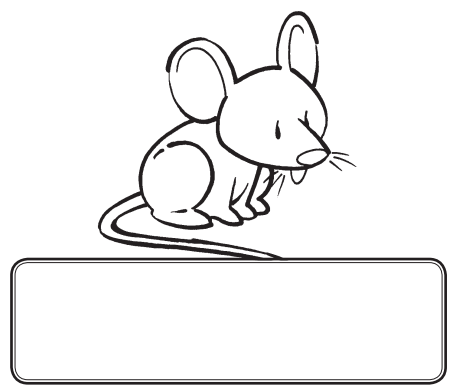
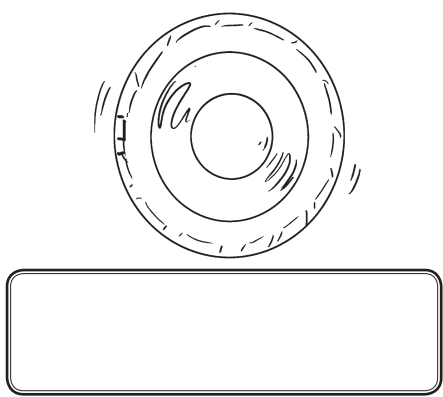
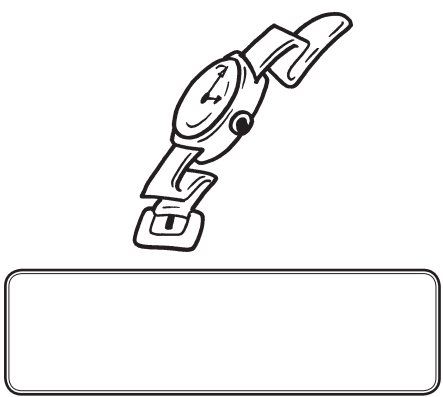
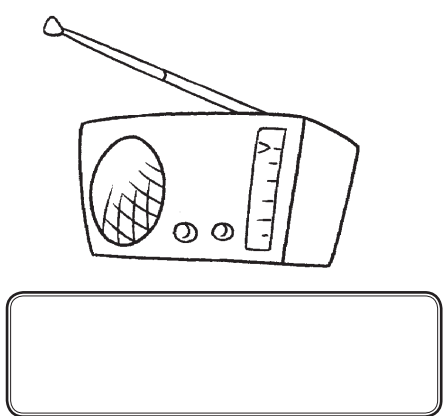
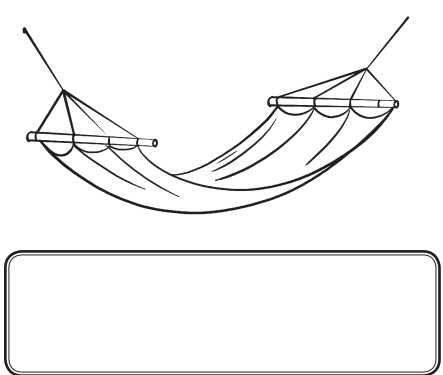

DATA:

🕒 PESQUISE, RECORTE E COLE, DE JORNAIS OU REVISTAS, PALAVRAS QUE TENHAM:

3 LETRAS



4 LETRAS

5 LETRAS

6 LETRAS

DATA: / /

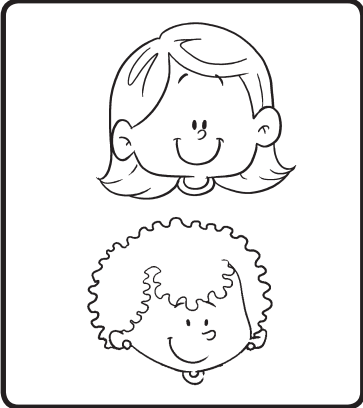
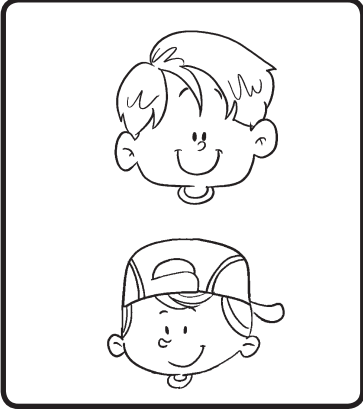
● PREENCHA A TABELINHA ESCRREVENDO OS NOMES DE ACORDO COM A FIGURA E A LETRA QUE COMEÇA.

NOME	COM		
	A	M	B
			
			
			

DATA: / /

● DE QUAL BRINQUEDO VOCÊ MAIS GOSTA?
CONTE E ANOTE QUANTAS LETRAS TEM CADA
PALAVRA.

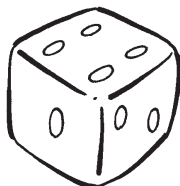

DADO

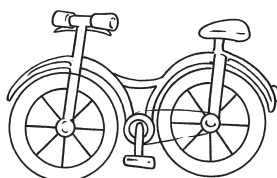

BICICLETA

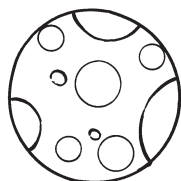

BOLA

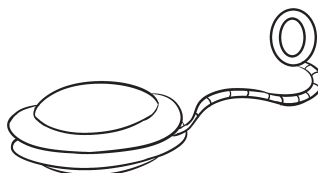

IOIÔ



PIPA

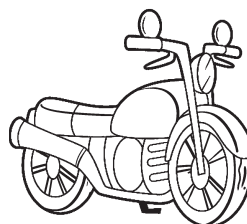

MOTO



PETECA

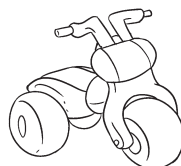

VELOCÍPEDE

● PINTE AS LETRAS QUE PERTENCEM À PALA-
VRA EM DESTAQUE.

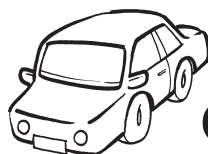

CARRO

R	I	A	H	B	C	N	D	R	O
---	---	---	---	---	---	---	---	---	---



BONECA

E	B	G	O	H	N	I	C	A	L
---	---	---	---	---	---	---	---	---	---

DATA: / /

● **ESCREVA O NOME DAS FIGURAS, DE ACORDO COM A NUMERAÇÃO.**

1.

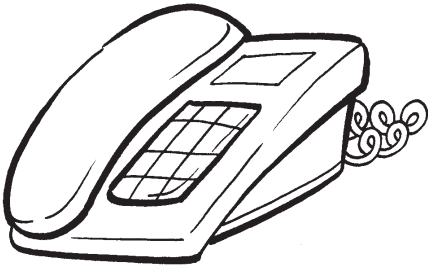

4.

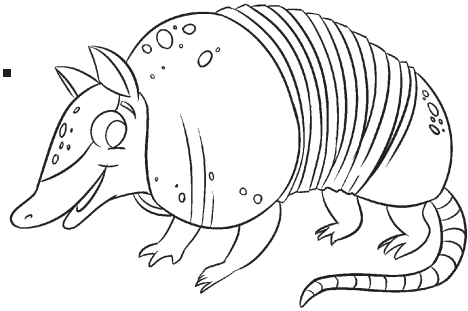

2.



5.

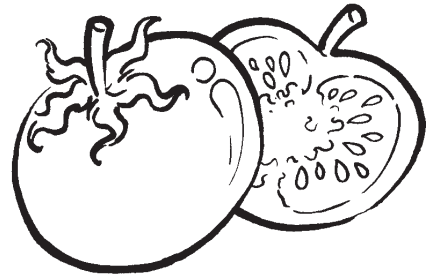

3.

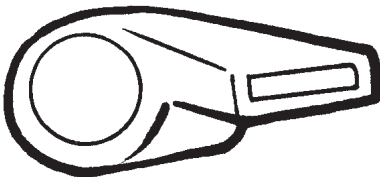

6.

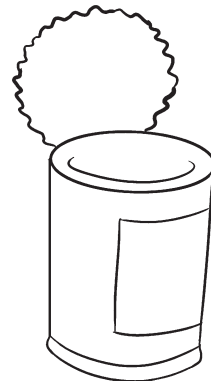

1.

4.

2.

5.

3.

6.

DATA: / /

🎯 PROCURE O NOME DAS FIGURAS ABAIXO NO CAÇA-PALAVRAS. DEPOIS, COPIE-O ABAIXO DE CADA FIGURA.

P	A	V	Ã	O	O	V	T
E	V	E	L	A	F	A	D
T	I	E	F	V	E	R	A
O	Ã	L	K	U	N	E	T
B	O	C	X	S	T	T	O
V	A	C	I	N	A	A	S
C	X	C	V	I	L	A	K

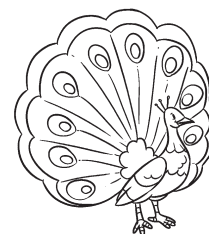
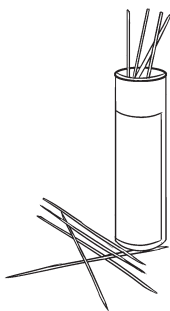
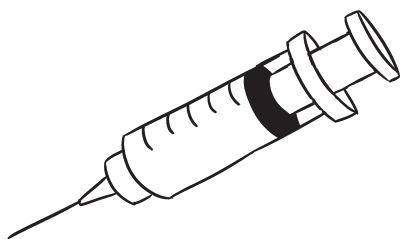

DATA:

● ORDENE AS SÍLABAS DAS PALAVRAS ABAIXO:

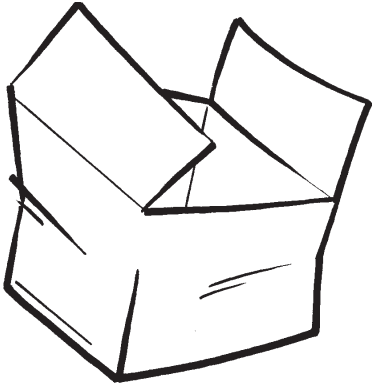

XA CAI



RI XE FE

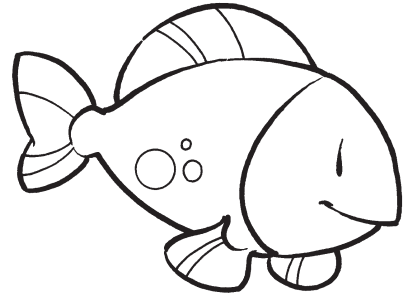

XE PEI



XO LI



CA RA XÍ

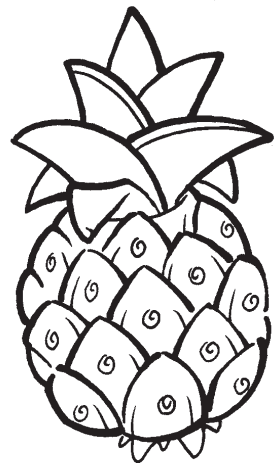

XI BA CA A

DATA: / /

🌀 **ESCREVA O NOME DOS NÚMEROS E RESPONDA.**

10

QUANTAS LETRAS HÁ?

QUANTAS VOGAIS HÁ?

QUANTAS CONSOANTES HÁ?

12

QUANTAS LETRAS HÁ?

QUANTAS VOGAIS HÁ?

QUANTAS CONSOANTES HÁ?

DATA:

🔍 PESQUISE, EM REVISTAS E JORNAIS, PALAVRAS COM A LETRA Z E COLE-AS AQUI.

🔍 COPIE ESTAS PALAVRAS ESCRITAS COM Z.

AZEITONA

DÚZIA

AZEITE

DEZENOVE

GOZADO

BATIZADO

DATA: / /

● ENCONTRE A LETRA K NA MÚSICA E CIRCULE-A.

 **VAMOS CANTAR!**

SÃO CINCO AMIGUINHAS
QUE SE QUEREM MUITO BEM.
A BRINCAR, SEMPRE JUNTINHAS,
SEM FAZER MAL A NINGUÉM.
SÃO ELAS KETLIN, KÁTIA
KELLY, KÊNIA E KAREN.

MELODIA: CIRANDA, CIRANDINHA



● COMPLETE O NOME DAS CINCO AMIGUINHAS
COM A LETRA K.



___ **ETLIN**



___ **AREN**



___ **ÊNIA**



___ **ELLY**

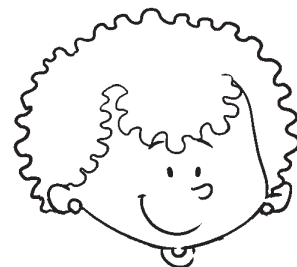

___ **ÁTIA**

DATA:

🎯 OUÇA A LEITURA DE PALAVRAS COM A LETRA Y.

YARA

YASMIM

YURI

YONÁ

YAKISOBA

YAGO

🎯 COMPLETE OS NOMES ABAIXO USANDO A LETRA Y.



____ONÁ

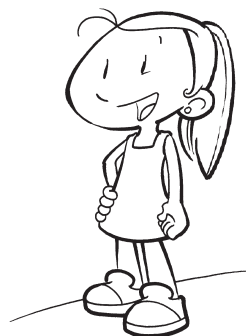

____ARA



____URI



____ASMIM

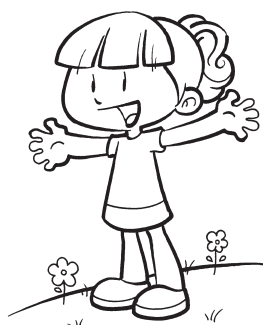

____EDA

DATA:

● OBSERVE AS DIVERSAS FORMAS DE ESCREVER A LETRA W.



● SUA PROFESSORA VAI DIZER O NOME DE VÁRIAS PESSOAS QUE INICIAM COM A LETRA W. ESCUTE E REPITA-OS.

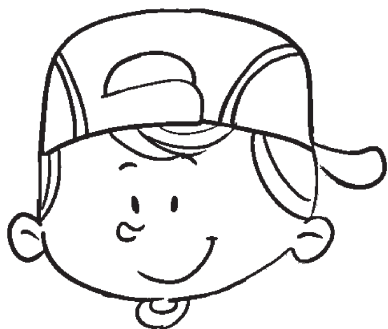

WALTER



WANDERLEY



WILSON



WILMA

DATA:

🎯 OUÇA E REPITA A LEITURA DOS NOMES. DEPOIS, LIGUE-OS ÀQUELES QUE INICIAM DO MESMO JEITO.

WERÔNICA

WALTER

WILSON

WANESSA

WOLNEI

WILLIAM

WALDO

WILTON

🎯 CIRCULE AS LETRAS QUE TÊM O MESMO SOM QUE A LETRA W PODE TER. A PROFESSORA VAI AJUDAR.

A

U

F

V

L

DATA: / /

● PINTE A FIGURA QUE REPRESENTA A RESPOSTA PARA AS ADIVINHAS.

1 TEM OLHOS, MAS NÃO ENXERGA;
TEM ÁGUA, MAS NÃO BEBE;
TEM CARNE, MAS NÃO COME;
TEM BARBA, MAS NÃO É HOMEM.

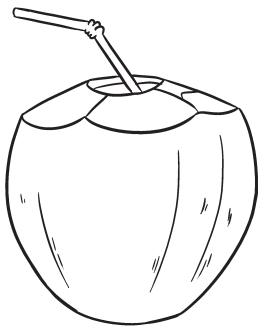

COCO

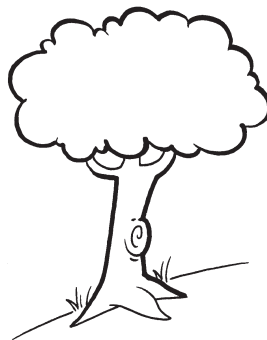

ÁRVORE

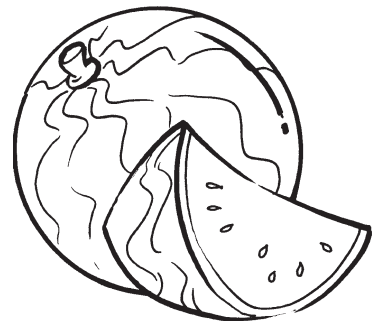

MELANCIA

2 BOTA OVO, MAS NÃO TEM PENA.
POR INCRÍVEL QUE PAREÇA
ANDA COM OS PÉS NA CABEÇA.

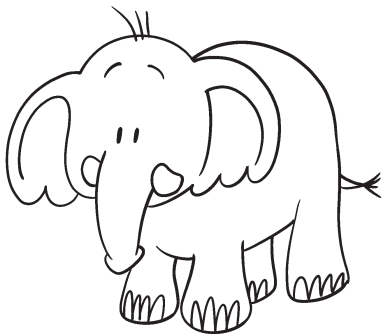

ELEFANTE



PIOLHO

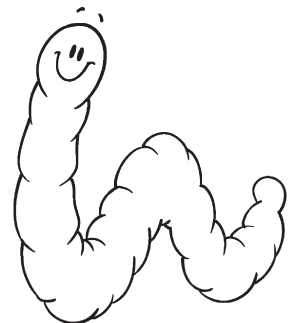

MINHOCA